

KATALOG IZDELKOV

2025

Enoslojni dimniški sistemi
Troslojni dimniški sistemi



 **Solinox**[®]
Chimney Systems

**Močan, varen in učinkovit.
To je Solinox.**

Saval Aleš Avsenek d.o.o.
info@dimniki-kamini.si
www.trgovina-kamin.si
www.dimniki-kamini.si

Kranjska cesta 2, 4240 Radovljica

Kontakt:

Trgovina Kamin: 040 364 636 / 04 53 000 40

Aleš Avsenek: 041 229 246



Predstavitev podjetja



TOVARNA IN PROIZVODNJA

SOLINOX

Predstavitev podjetja
Zgodovina tovarne



SOLINOX ENOSLOJNI DIMNIŠKI SISTEMI

Splošne informacije
Tehnični podatki in dimenzije



SOLINOX TROSLOJNI DIMNIŠKI SISTEMI

Splošne informacije
Tehnični podatki in dimenzije

Zgodovina

Solinox je turško podjetje, ki se ukvarja s proizvodnjo in razvojem visokokakovostnih dimniških sistemov iz nerjavečega jekla. V več kot 23 letih so se postopoma razvili v enega največjih in najbolj uglednih proizvajalcev dimnikov iz nerjavečega jekla v Turčiji.

Nenehno spremljajo in se prilagajajo najnovejšim trendom in inovacijam na področju tehnologije ter jih uspešno vključujejo v izdelke. Cilj je ponuditi funkcionalne rešitve, ki združujejo kakovost, estetiko in dostopnost.



2000

Ustanovljeno

2007

Začetek proizvodnje

2013

Prvi
izvoz



2021
Inovacije

2024
Nova
proizvodnja

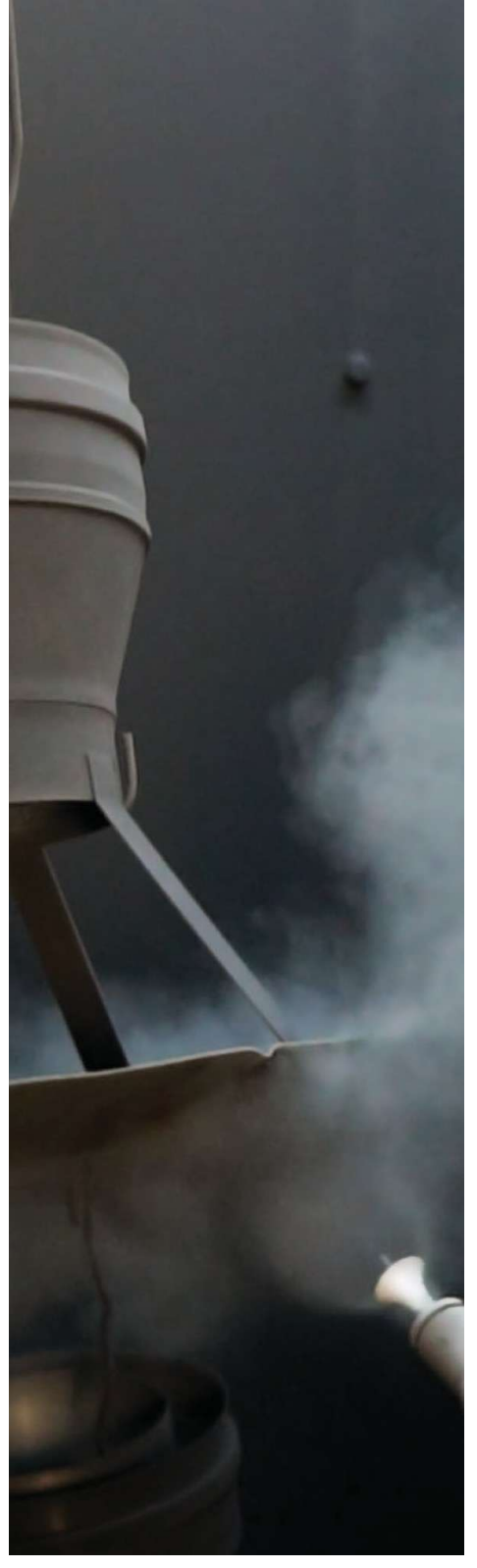
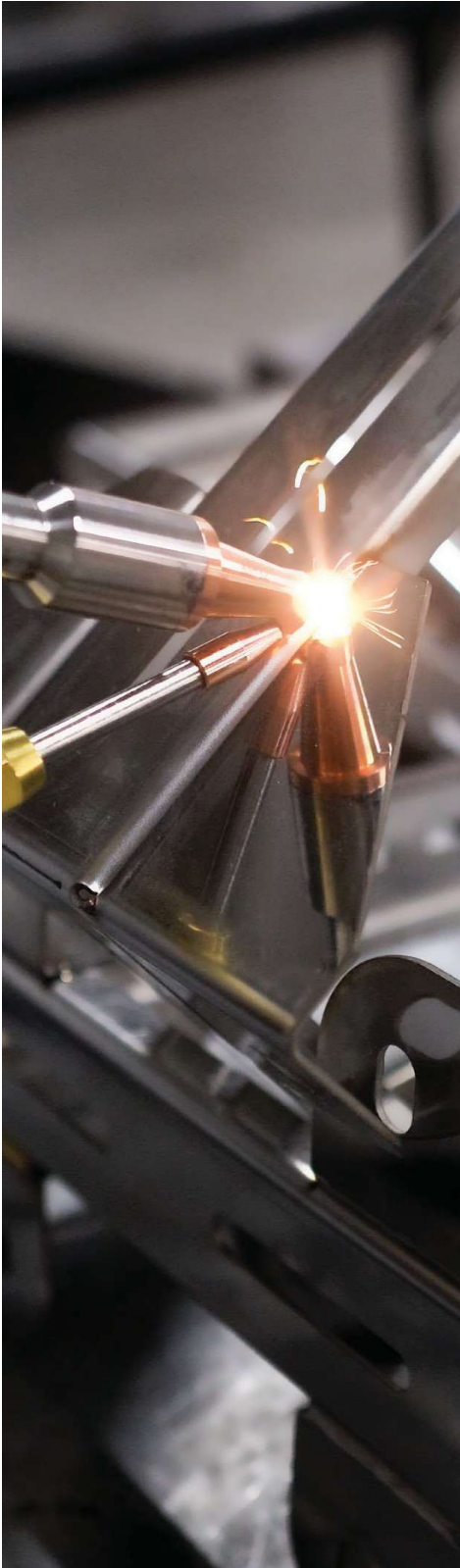

O nas



V podjetju Solinox skrbno upravljamo naše proizvodne procese, da zagotovimo najvišje standarde kakovosti pri dimniških sistemih. Ponosni smo na naše mednarodno certificirane izdelke, ki zagotavljajo zanesljivost in varnost. Naša najsodobnejša proizvodna zmogljivost je opremljena z naprednimi stroji in natančnimi procesi nadzora kakovosti. Vsak izdelek, ki ga proizvodimo, je zasnovan za dolgotrajno uporabo, visoko vzdržljivost in varno delovanje.

Solinox sistemi zagotavljajo certificirano kakovost in najsodobnejšo proizvodnjo!

Certifikati

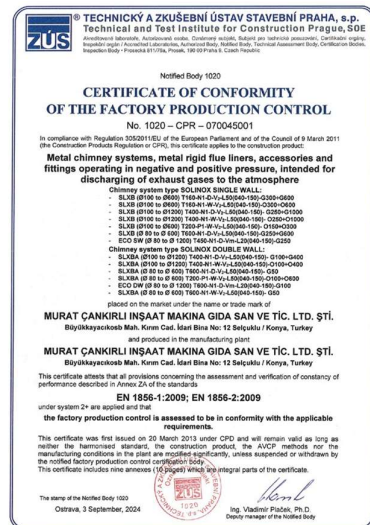

SOLINOX ENOSLOJNI DIMNIŠKI SISTEMI



SS 304-316L



Enostavna in hitra montaža



Industrijska in
stanovanjska
uporaba



Zanesljiva proizvodnja

Model SOLINOX SW je enoslojni dimniški sistem, ki je izdelan iz nerjavečega jekla 316L (1.4404) ali 304 (1.4301). Delovna temperatura sistema je do 600 °C. Ta model, je primeren za suhe in vlažne delovne pogoje in se lahko uporablja za naprave na trdo, tekoče in plinasto gorivo.

ARTIKEL :

Premer: 80 mm – 600 mm
Debelina: 0,40 mm - 1,00 mm

MATERIAL :

AISI 316L (1.4404)
AISI 304 (1.4301)



SS končna obdelava

TEHNIČNE ZNAČILNOSTI:

Delovni pogoji: Suho (D)
Vlažno (W) – kondenzacija

Pozitivno (P1) Prisilno
 Negativni (N1) Naravni vlek

Tlačni razred: 40 Pa
do 200 Pa

Delovna temperatura: 200°C s tesnilom
600°C brez tesnila



Trdno



Tekoče



Plin

ODOBRITVE:

SLXB T200-P1-W-V2-L50 (040-150) O150
SLXB T400-N1-W-V2-L50 (040-150) O150
SLXB T600-N1-D-V2-L50 (040-150) G250
ECO SW T450-N1-D-Vm-L20 (040-150) G250



PODROČJA UPORABE



Prezračevalne
naprave



Centralno
ogrevanje



Kamin



Krušne peči





Notranja
namestitev

Namestitev v
notranjih
prostorih



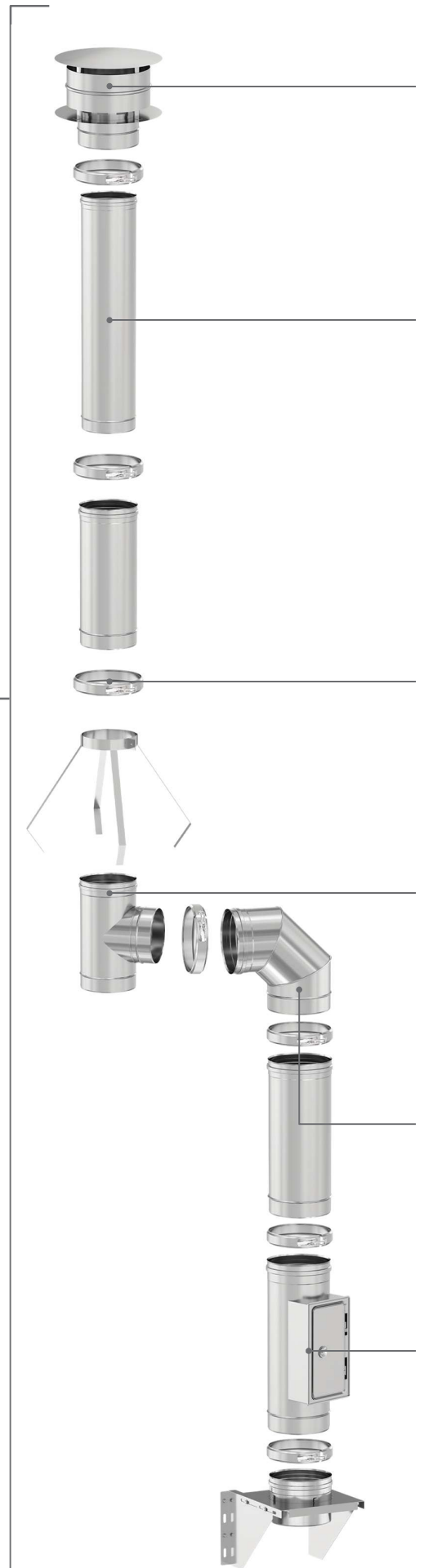
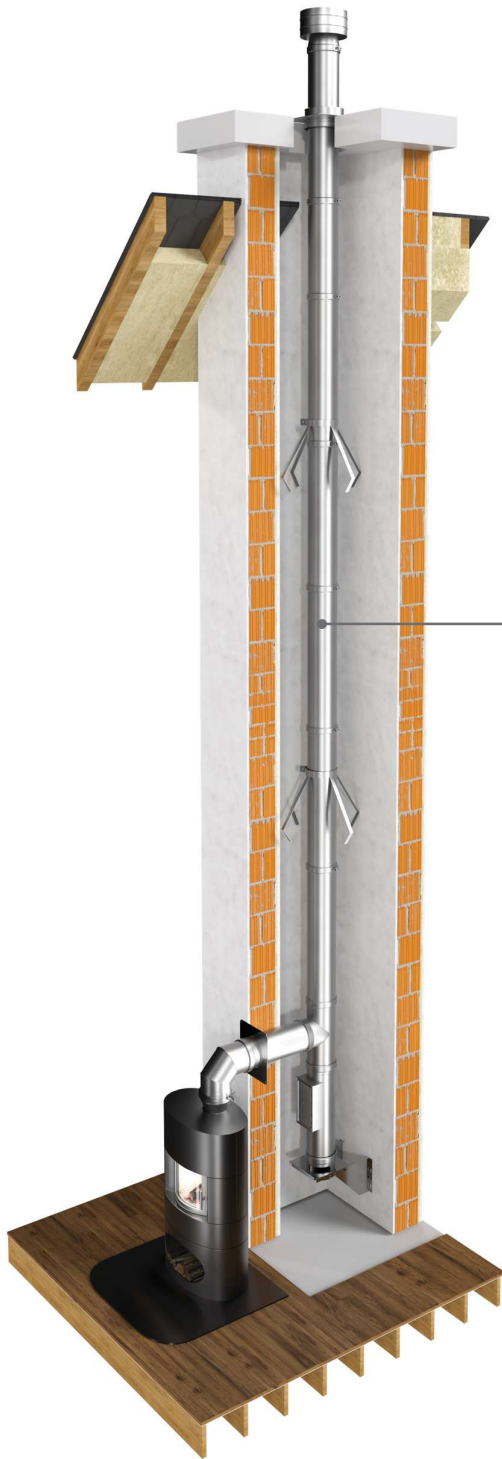

Enoslojni dimniški sistemi so primerni za široko paleto uporabe in različne vrste vgradnje. Spodnji diagram prikazuje vzorčno vgradnjo, ki prikazuje vse skupine komponent.

Zaključki



Proti dežna kapa



Proti vetrni pokrov



Stožčasta kapa



Vetrna kapa



Konusni zaključek



Deflektor



Perforirani zaključek



H kapa

Cevi



Cev 250mm



Cev 500mm



Cev 1000mm



Nastavljiva cev
270 mm - 470 mm

Nosilci



Tanka spojna objemka



Spojna objemka



Stenski nosilec 5



Stenski nosilec 11



Stenski nosilec 21



Stenski nosilec 35



Podaljšek nosilca



Nosilni element nastavkom in trikotno konzolo

T-kosi



T-kos 87°



T-kos 90°



T-kos 45°

Kolena



Koleno 15°



Koleno 30°



Koleno 45°



Koleno 87°



90° Koleno



90° koleno z revizijo

Artikli s čistilnim elementom



VZ čistilni element



Cev z okroglo revizijsko odprtino



90° T-kos z revizijo



VZ dezov vgradni



Testna enota 250 mm



Testna enota 500 mm



Testna enota 1000 mm

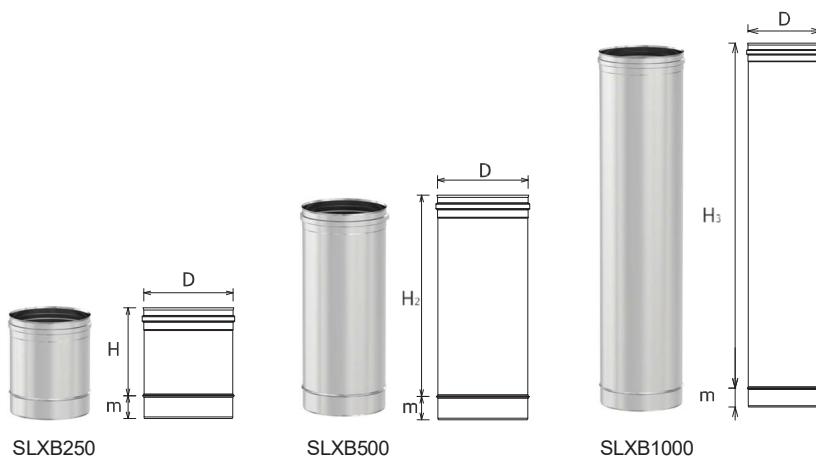

V tem poglavju so podrobno predstavljene vse modularne komponente dimniškega sistema SW. Za vsak del so na voljo tabele tehničnih dimenzij, vključno s koleni, prehodnimi kosi, priključnimi elementi, nosilnimi konzolami in zaključnimi komponentami. Vse tehnične informacije, potrebne za izbiro izdelka in načrtovanje namestitve, so zbrane tukaj, da se zagotovi pravilna in varna namestitev sistema.

Ravna cev

SLXB

D	80	100	130	150	180	200	230	250	280	300	350	400	450	500	550	600	
H ₁											200						
H ₂											450						
H ₃											950						
m											50						

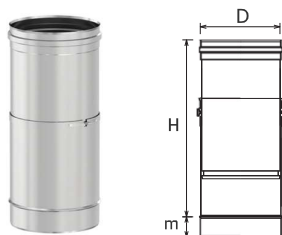

Nastavljiva cev (290 mm - 470 mm)

SLXUB 47

D	80	100	130	150	180	200	230	250	280	300	350	400	
H _{min.}							240						
H _{max.}							420						
m							50						

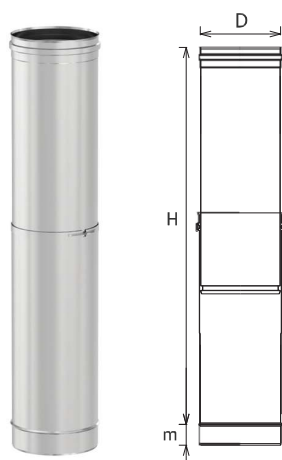

Nastavljiva cev (550 mm - 900 mm)

SLXUB90

D	80	100	130	150	180	200	230	250	280	300	350	400	
H _{min.}							500						
H _{max.}							850						
m							50						

Koleno 15°

SLXD15

D	80	100	130	150	180	200	230	250	280	300	350	400	450	500	550	600
A	105	105	105	105	105	105	105	118	118	118	118	118	125	125	125	125
B	95	105	105	105	105	105	105	118	118	118	118	118	125	125	125	125
m	50															

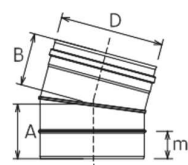

Koleno 30°

SLXD 30

D	80	100	130	150	180	200	230	250	280	300	350	400	450	500	550	600
A	100	105	118	118	118	118	130	130	130	143	143	155	155	170	170	183
B	100	105	118	118	118	118	130	130	130	143	143	155	155	170	170	183
m	50															

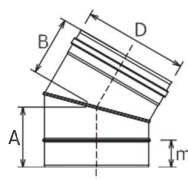

Koleno 45°

SLXD 45

D	80	100	130	150	180	200	230	250	280	300	350	400	450	500	550	600
A	100	118	125	125	143	143	143	155	155	155	170	183	200	205	220	250
B	100	118	125	125	143	143	143	155	155	155	170	183	200	205	220	250
m	50															

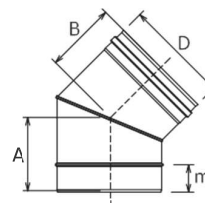

Koleno 87°

SLXD 87

D	80	100	130	150	180	200	230	250	280	300	350	400	450	500	550	600
A	85	102	110	119	130	130	140	136	155	156	163	173	185	199	204	219
B	80	105	120	127	140	140	160	168	165	188	209	230	251	272	293	313
C	85	102	110	119	130	130	140	136	155	156	163	173	185	199	204	219
E	104	129	133	138	144	134	144	136	139	147	145	145	149	154	150	155
m	50															

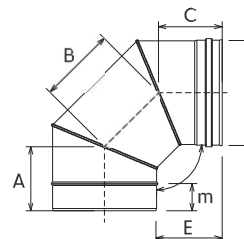

Koleno 90°

SLXD 90

D	80	100	130	150	180	200	230	250	280	300	350	400	450	500	550	600
A	89	102	110	119	130	126	140	136	155	156	163	172	184	199	204	218
B	73	106	120	127	140	148	160	168	165	188	209	231	252	272	293	314
C	89	102	110	119	130	126	140	136	155	156	163	172	184	199	204	218
E	100	127	130	134	139	131	138	130	132	139	136	135	137	141	136	140
m	50															

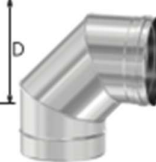
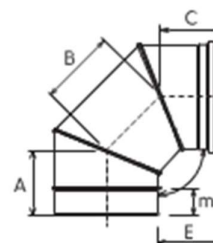

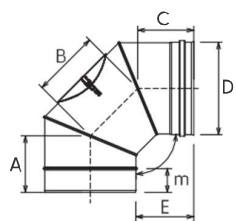

Koleno 90° z revizijsko odprtino

SLXD 90 i

D	80	100	130	150	180	200	230	250	280	300	350	400	450	500	550	600
A	89	102	110	119	130	126	140	136	155	156	163	172	184	199	204	218
B	73	106	120	127	140	148	160	168	165	188	209	231	252	272	293	314
C	89	102	110	119	130	126	140	136	155	156	163	172	184	199	204	218
E	100	127	130	134	139	131	138	130	132	139	136	135	137	141	136	140
m	50															

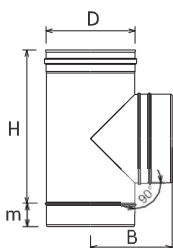

T-kos 87°

SLXT87

D	80	100	130	150	180	200	230	250	280	300	350	400	450	500	550	600
H	200	283	350	350	350	350	450	450	450	450	550	550	650	650	700	950
B	105	135	150	160	175	185	200	210	225	235	270	295	320	345	395	420
m	50															

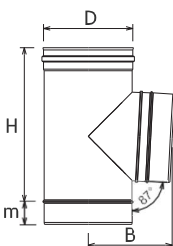

T-kos 90°

SLXT90

D	80	100	130	150	180	200	230	250	280	300	350	400	450	500	550	600
H	200	283	350	350	350	350	450	450	450	450	550	550	650	650	700	950
B	105	135	150	160	175	185	200	210	225	235	270	295	320	345	395	420
m	50															

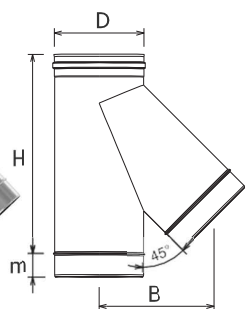

T – kos 45°

SLXT135

D	80	100	130	150	180	200	230	250	300	350	400	450	500	550	600	
H	250	283	283	350	450	450	550	550	650	650	950	950	950	999	1247	
B	155	175	180	215	275	275	330	330	390	400	555	565	570	580	700	
m	50															



VZ dezov vgradni

d	100	130	150	180	200	230	250	300	350	400	450	500	550	600	
H	400														
C															
m															

Cev z revizijsko odprtino (VZ)

SLXTKB

D	130	150	180	200	230	250	280	300	350	400	450	500	550	600
A														
H														
m														

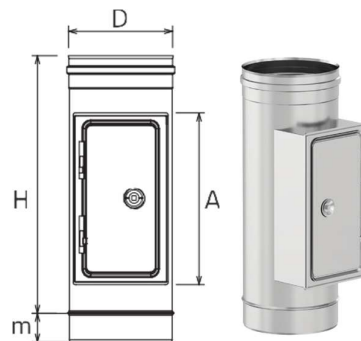

Cev z okroglo revizijsko odprtino

SLXBI

D	80	100	130	150	180	200	230	250	280	300	350	400	450	500	550	600
A									140							
H									450							
m									50							

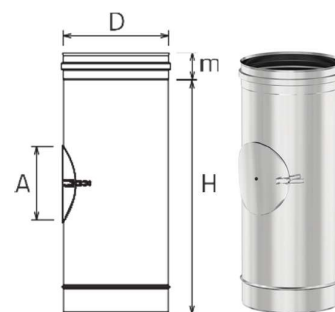

T-kos z revizijskimi vratci

SLXTKT

D	130	150	180	200	230	250	280	300	350	400	450	500	550	600
H	350	350	350	350	450	450	450	450	550	550	650	650	700	950
B	150	160	175	185	200	210	225	235	270	295	320	345	395	420
A	265	285	315	335	365	385	415	435	495	544	595	645	720	770
m									50					

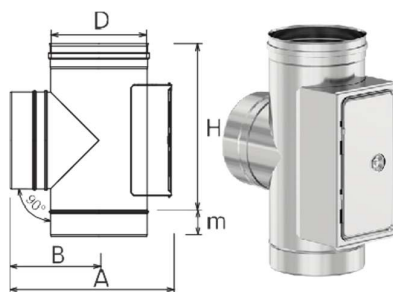

Redukcija

SLXR

D	80	100	130	150	180	200	230	250	280	300	350	400	450	500	550	600
H											120					
m											50					

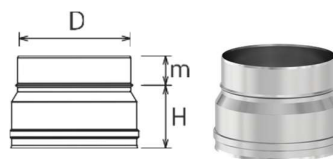

Kvadratni prehodni kos na okroglo

SLXKR

D	80	100	130	150	180	200	230	250	280	300	350	400	450	500	550	600
AxA	-	-	-	-	-	-	-	-	-	-	-	-	-	-	-	-
H	-	-	-	-	-	-	-	-	-	-	-	-	-	-	-	-

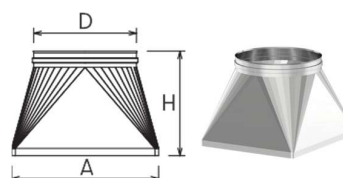

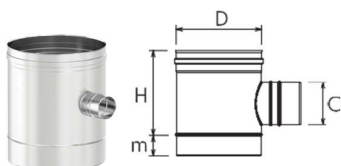

Testna enota 250 mm

SLXCOB 250

D	80	100	130	150	180	200	230	250	280	300	350	400	450	500	550	600
H									200							
m									50							

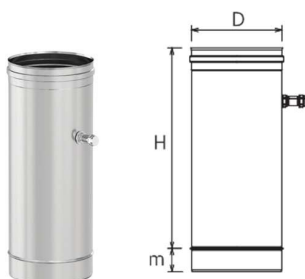

Testna enota 500 mm

SLXOB 500

D	80	100	130	150	180	200	230	250	280	300	350	400	450	500	550	600
H									450							
m									50							

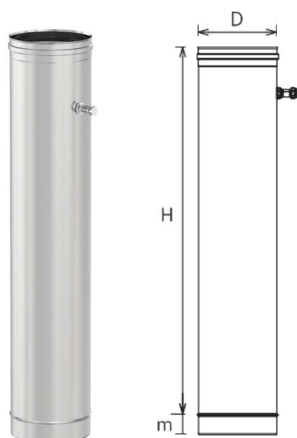

Testna enota 1000 mm

SLXOB 1000

D	80	100	130	150	180	200	230	250	280	300	350	400	450	500	550	600
H									950							
m									50							

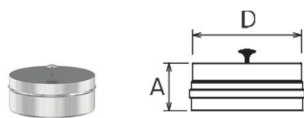

Dno dimnika brez odvoda

SLXDTK

D	80	100	130	150	180	200	230	250	280	300	350	400	450	500	550	600
A									80							

Dno dimnika z odvodom

SLXYT

D	80	100	130	150	180	200	230	250	300	350	400	450	500	550	60
A	80														

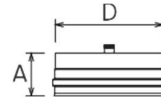

Dno dimnika s stranskim odvodom

SLXYT

D	150	180	200	230	250	300	350	400	450	500	550	600
A	80											

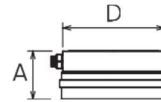

Proti dežna kapa

SLXYKS

D	80	100	130	150	180	200	230	250
H	120							
m	50							

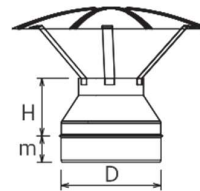

Vetрна kapa

SLXRKS

D	80	100	130	150	180	200	230	250
H	200	200	200	200	200	250	250	250
m	50							

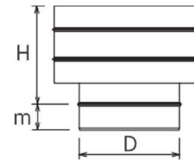

Stožčasta kapa

SLXRKSL

D	100	130	150	180	200	230	250
H	200						
m	50						

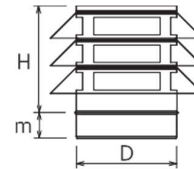

Protivetrni pokrov

SLXRKSS

D	100	130	150	180	200	230	250
H	200	200	200	200	250	250	250
m	50						

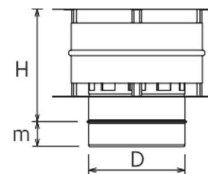

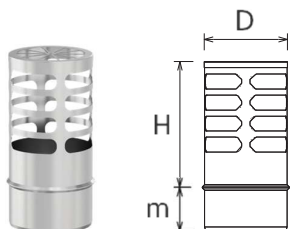

Perforirani zaključek

SLXRBS

D	80	100	130	150
H	200			
m	50			

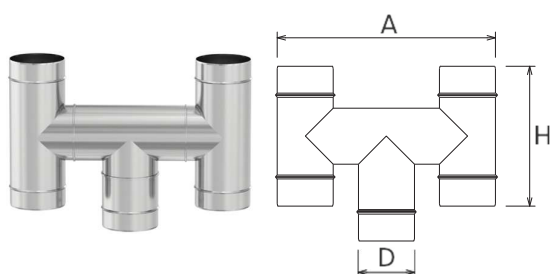

H kapa

SLXHHC

D	100	130	150	180	200	230	250
H	283	350	350	350	350	450	450
A	400	490	550	640	700	790	850

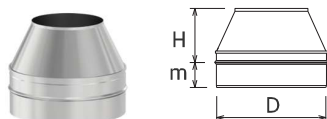

Konusni zaključek

SLXKS

D	80	100	130	150	180	200	230	250	300	350	400	450	500	550	600
H	140											170			
m	50											50			

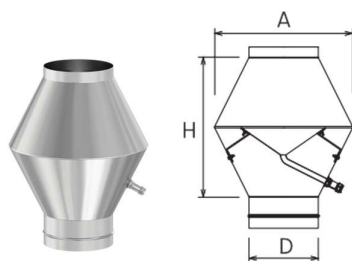

Deflektor

SLXJC

D	100	130	150	180	200	230	250	280	300	350	400	450	500	550	600
H	200	260	300	360	400	460	500	560	600	700	800	900	900	950	1000
A	175	225	260	315	350	400	440	495	525	600	650	700	750	800	850

Tanka spojna objemka

AKSLXBKI

D	80	100	130	150	180	200	230	250	300	350	400	450	500
H	17												

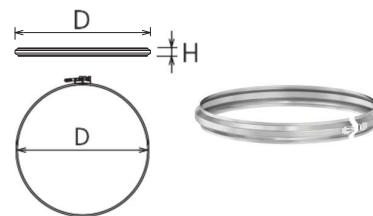

Spojna objemka

AKSLXBK

D	80	100	130	150	180	200	230	250	300	350	400	450	500	550	600
H	47														

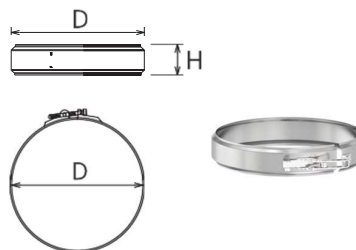

Nosilni podstavek

AKSLXTT

D	80	100	130	150	180	200	230	250	300	350	400	450	500	550	600
A	80	100	130	150	180	200	230	250	300	350	400	450	500	550	600
B	360														

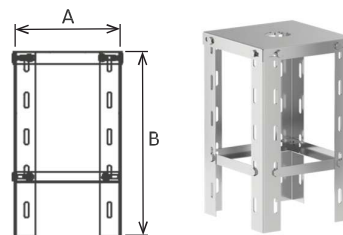

Nosilni element z nastavkom in trikotno konzolo

AKSLXBTS

D	80	100	130	150	180	200	230	250	300	350	400	450	500	550	600
A	150	170	200	220	250	270	300	320	370	420	470	520	570	620	670
H	140	160	190	210	240	260	290	310	260	410	460	510	560	610	660

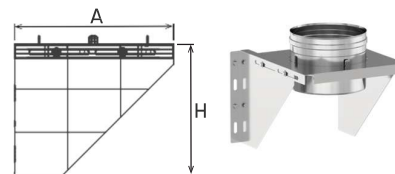

Distančnik

AKSLXHK

D	80	100	130	150	180	200	230	250	300	350	400	450	500	550	600
----------	----	-----	-----	-----	-----	-----	-----	-----	-----	-----	-----	-----	-----	-----	-----

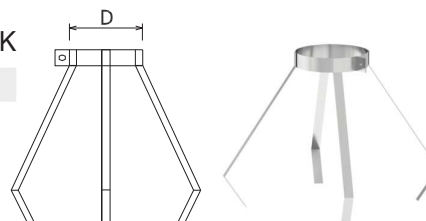

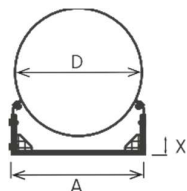

Zidno držalo (50 mm od stene)

AKSLXDSK

D	80	100	130	150	180	200	230	250	280	300
A	105	130	160	175	205	225	255	279	280	300
X	50 mm									

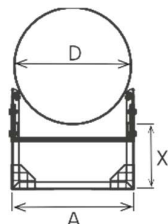

Zidno držalo tip 11 (70-210 mm od stene)

AKSLXDSK11

D	80	100	130	150	180	200	230	250	280	300
A	105	130	163	178	208	228	258	279	283	303
X	70-110 mm									

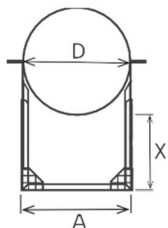

Zidno držalo tip 21 (120-210 mm od stene)

AKSLXDSK 21

D	100	130	150	180	200	230	250
A	107	137	157	187	217	247	277
X	120 - 210 mm						

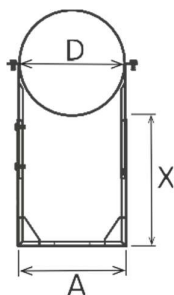

Zidno držalo tip 35 (220-350 mm od stene)

AKSLXDSK35

D	100	130	150	180	200	230	250
A	107	137	157	187	217	247	277
X	220 - 350 mm						

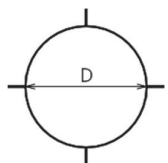

Sidna objemka (4)

AKSLXGK

D	80	100	130	150	180	200	230	250	300	350	400	450	500	550	600
----------	----	-----	-----	-----	-----	-----	-----	-----	-----	-----	-----	-----	-----	-----	-----

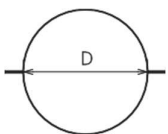

Sidna objemka

AKSLX AK

D	80	100	130	150	180	200	230	250	300	350	400	450	500	550	600
----------	----	-----	-----	-----	-----	-----	-----	-----	-----	-----	-----	-----	-----	-----	-----

Nastavljiva podpora

AKSLXHT

d	80	100	130	150	180	200	230	250	300	350	400	450	500	600
D	130	150	180	230	250	250	280	300	350	400	450	500	550	650
A	200 / 300 / 400 / 500 / 600 mm													

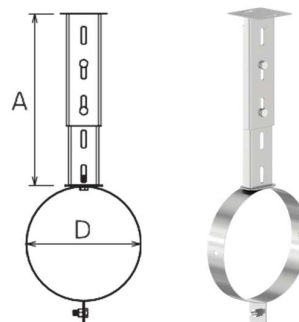

Dolga nastavljiva podpora

AKSLXHTU

d	80	100	130	150	180	200	230	250	300	350	400	450	500	550	600
D	130	150	180	230	250	250	280	300	350	400	450	500	550	600	650
A	610 - 1000 mm														

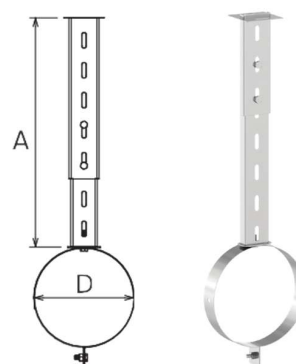

Ovalna stenska rozeta 30°

AKSLXOK30



D	80	100	130	150	180	200	230	250	280	300	350	400	450
A	280	300	330	350	380	400	430	450	480	500	550	600	650
B	150	170	185	198	215	227	244	255	273	285	313	340	370

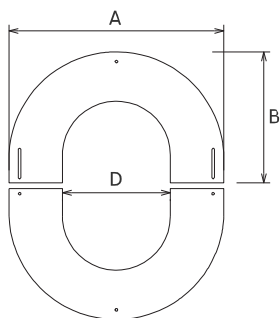

Ovalna stenska rozeta 45°

AKSLXOK45

D	80	100	130	150	180	200	230	250	280	300	350	400	450
A	280	300	330	350	380	400	430	450	480	500	550	600	650
B	175	190	205	218	239	253	274	288	310	324	359	385	420

Ovalna stenska rozeta 90°

AKSLXOK90

D	80	100	130	150	180	200	230	250	280	300	350	400	450
A	280	300	330	350	380	400	430	450	480	500	550	600	650

Stenska rozeta 30°

AKSLXDK30

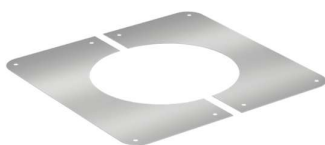

D	80	100	130	150	180	200	230	250	280	300	350	400	450
A	280	300	330	350	380	400	430	450	480	500	550	600	650
B	145	160	175	190	205	220	235	250	265	280	310	335	360

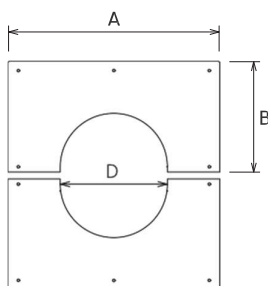

Stenska rozeta 45°

AKSLXDK45

D	80	100	130	150	180	200	230	250	280	300	350	400	450
A	280	300	330	350	380	400	430	450	480	500	550	600	650
B	155	175	195	210	230	245	270	280	300	320	350	410	460

Stenska rozeta 90°

AKSLXDK90

D	80	100	130	150	180	200	230	250	280	300	350	400	450
A	280	300	330	350	380	400	430	450	480	500	550	600	650
B	140	160	175	185	200	210	225	235	250	260	285	310	335

Ø	vertikalno			vodoravno			navpično			vodoravno		
	DOLŽINA	ODMIK	VIŠINA	DOLŽINA	ODMIK	VIŠINA	DOLŽINA	ODMIK	VIŠINA	DOLŽINA	ODMIK	VIŠINA
80	1000	863	1023	1000	913	973	1000	933	828	1000	983	778
	500	509	669	500	562	619	500	579	474	500	629	424
	250	332	492	250	382	442	250	402	297	250	452	247
	-	191	351	-	241	301	-	261	156	-	311	106
100	1000	896	1080	1000	964	963	1000	1005	870	1000	1074	803
	500	543	727	500	610	609	500	652	517	500	719	449
	250	366	550	250	434	433	250	475	340	250	542	272
	-	225	409	-	292	291	-	333	198	-	401	131
130	1000	909	1085	1000	984	1010	1000	1038	888	1000	1113	813
	500	555	732	500	630	657	500	685	535	500	760	460
	250	379	555	250	454	480	250	508	359	250	583	283
	-	237	414	-	312	289	-	366	216	-	441	141
150	1000	979	1179	1000	1054	1104	1000	1048	888	1000	1123	813
	500	590	790	500	665	715	500	695	534	500	770	459
	250	590	790	250	665	715	250	518	361	250	593	282
	-	272	472	-	374	397	-	376	216	-	452	141
180	1000	1013	1265	1000	1105	1173	1000	1105	980	1000	1198	838
	500	659	912	500	802	819	500	752	627	500	844	484
	250	482	735	250	625	642	250	575	450	250	668	308
	-	341	594	-	484	501	-	434	309	-	526	166
200	1000	1013	1255	1000	1155	1163	1000	1115	930	1000	1208	838
	500	659	901	500	801	809	500	761	576	500	854	484
	250	482	725	250	625	632	250	585	400	250	678	308
	-	341	584	-	483	491	-	443	258	-	536	166
230	1000	1069	1347	1000	1162	1254	1000	1130	930	1000	1223	838
	500	716	993	500	808	901	500	777	577	500	869	484
	250	539	817	250	632	724	250	600	400	250	693	308
	-	398	675	-	490	583	-	459	259	-	551	166
250	1000	1078	1358	1000	1183	1253	1000	1171	961	1000	1276	856
	500	725	1005	500	828	900	500	817	607	500	922	502
	250	548	828	250	653	723	250	640	430	250	745	325
	-	407	687	-	512	582	-	499	289	-	604	184
300	1000	1139	1444	1000	1244	1339	1000	1196	961	1000	1301	856
	500	785	1090	500	940	985	500	842	607	500	947	502
	250	608	913	250	763	808	250	665	430	250	770	325
	-	467	772	-	622	667	-	524	289	-	629	184

Ø	vertikalno			vodoravno			navpično			vodoravno		
	DOLŽINA	ODMIK	VIŠINA	DOLŽINA	ODMIK	VIŠINA	DOLŽINA	ODMIK	VIŠINA	DOLŽINA	ODMIK	VIŠINA
80	1000	1158	550	1000	1268	285	1000	778	928	1000	828	918
	500	725	300	500	785	155	500	424	574	500	474	564
	250	508	175	250	546	91	250	247	397	250	297	387
	-	335	75	-	350	39	-	106	256	-	156	246
100	1000	1206	555	1000	1318	287	1000	803	988	1000	870	920
	500	773	305	500	834	158	500	449	634	500	517	567
	250	557	180	250	593	93	250	272	457	250	340	390
	-	384	80	-	400	41	-	131	316	-	198	248
130	1000	1268	567	1000	1332	287	1000	814	1014	1000	888	938
	500	835	317	500	849	158	500	460	660	500	535	585
	250	618	193	250	608	93	250	284	484	250	359	408
	-	445	92	-	415	41	-	142	342	-	216	266
150	1000	1278	568	1000	1343	287	1000	813	1013	1000	888	938
	500	845	318	500	860	158	500	5	663	500	534	585
	250	629	193	250	94	621	250	282	486	250	361	408
	-	455	93	-	425	41	-	143	347	-	216	266
180	1000	1293	568	1000	1357	287	1000	568	1168	1000	930	980
	500	860	318	500	874	158	500	318	735	500	577	627
	250	643	193	250	633	93	250	193	518	250	400	450
	-	470	93	-	440	41	-	93	345	-	259	309
200	1000	1303	568	1000	1367	287	1000	838	1073	1000	930	980
	500	870	318	500	884	158	500	484	719	500	576	629
	250	653	193	250	643	93	250	308	543	250	400	450
	-	480	93	-	450	41	-	166	401	-	258	308
230	1000	1415	580	1000	1382	287	1000	838	1073	1000	930	980
	500	932	330	500	899	158	500	484	719	500	577	627
	250	715	205	250	658	93	250	308	543	250	400	450
	-	542	105	-	465	41	-	166	401	-	259	309
250	1000	1375	580	1000	1441	294	1000	856	1116	1000	961	1011
	500	942	330	500	958	164	500	502	762	500	607	657
	250	725	205	250	716	100	250	325	585	250	430	480
	-	552	105	-	524	48	-	184	444	-	289	339
300	1000	1446	593	1000	1467	294	1000	856	1116	1000	961	1011
	500	1013	343	500	983	164	500	502	762	500	607	607
	250	797	218	250	742	100	250	325	585	250	430	430
	-	624	118	-	549	48	-	184	444	-	289	289

Ø	KOLENO 30° vertikalni			KOLENO 15° vodoravni		
	DOLŽINA	ODMIK	VIŠINA	DOLŽINA	ODMIK	VIŠINA
80	1000	550	1103	1000	285	1213
	500	300	670	500	155	730
	250	175	453	250	91	491
	-	75	280	-	39	295
100	1000	555	1121	1000	287	1233
	500	305	688	500	158	750
	250	180	472	250	93	508
	-	80	299	-	315	41
130	1000	567	1168	1000	287	1232
	500	317	735	500	158	749
	250	193	518	250	93	508
	-	92	345	-	41	315
150	1000	568	1168	1000	287	1232
	500	318	735	500	158	749
	250	193	518	250	93	508
	-	93	345	-	41	315
180	1000	568	1168	1000	287	1232
	500	318	735	500	158	749
	250	193	518	250	93	508
	-	93	345	-	41	315
200	1000	568	1168	1000	287	1232
	500	318	735	500	158	749
	250	193	518	250	93	508
	-	93	345	-	41	315
230	1000	580	1215	1000	287	1232
	500	330	782	500	158	749
	250	205	565	250	93	508
	-	105	392	-	41	315
250	1000	580	1215	1000	294	1281
	500	330	782	500	164	798
	250	205	565	250	100	556
	-	105	392	-	48	364
300	1000	593	1261	1000	294	1282
	500	343	828	500	164	798
	250	218	612	250	100	557
	-	118	439	-	48	364

SOLINOX TROSLOJNI DIMNIŠKI SISTEMI



Enostavna in hitra montaža



Primerno za notranjo in
zunanjo uporabo

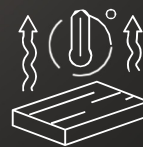

Izolacija iz kamene
volne visoke gostote

Dimniški sistem modela SOLINOX DW25 ima notranjo steno iz 316L (1.4404) ali 304 (1.4301) in zunanjo steno iz 304 (1.4301) ali 430 (1.4016). Zahvaljujoč izolaciji visoke gostote so toplotne izgube minimalne. Primeren je za vlažne in suhe delovne pogoje. Ta model, ki se lahko uporablja v sistemih s pozitivnim in negativnim tlakom, je primeren za uporabo naprav na trdno, tekoče in plinsko gorivo.

ARTIKEL:

Premer: 80 mm - 600 mm
Debelina: 0,40 mm - 1,00 mm

MATERIAL :

AISI 316L (1.4404)
AISI 304 (1.4301)



SS končna
obdelava



Barvana
površina

TEHNIČNE ZNAČILNOSTI:

Delovni pogoji: Suho (D)
Vlažno (W) – kondenzacija

Pozitivno (P1) Prisilno
Negativno (N1) Naravni vlek

Tlačni razred: 40 Pa
200 Pa

Delovna temperatura: 200°C s tesnilom
600°C brez tesnila



Trdno



Tekoče



Plin

ODOBRITVE :

SLXBA T200-P1-W-V2-L50 (040-150) O100
SLXBA T600-N1-D-V2-L50 (040-150) G50
SLXBA T600-N1-W-V2-L50 (040-150) G50
ECO DW T600-N1-D-Vm-L20 (040-150) G100



PODROČJA UPORABE



Prezračevalne
naprave



Centralno
ogrevanje



Kamin



Krušne peči



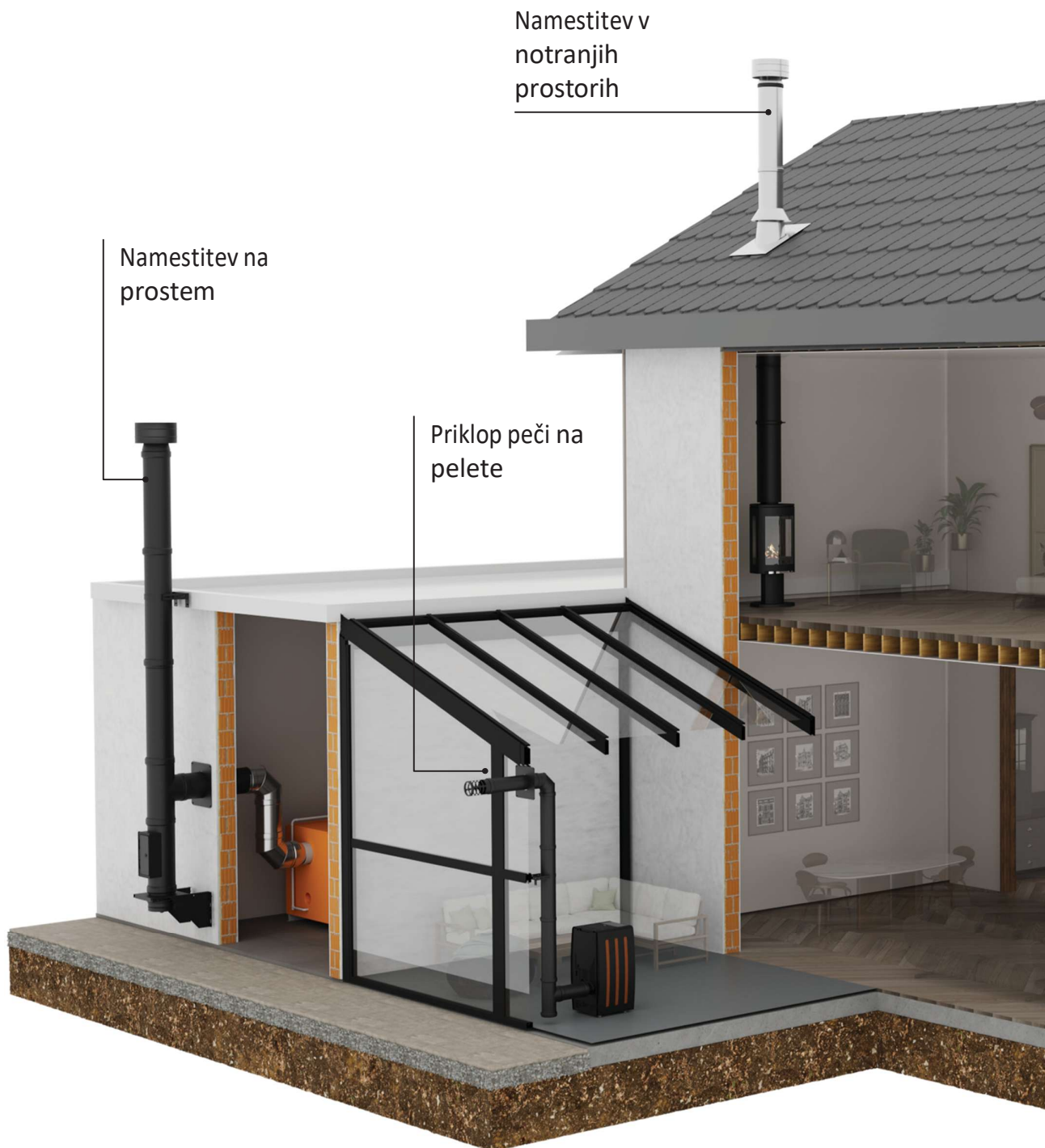

Namestitev v notranjih
prostorih s fleksibilno
cevjo

Namestitev
na prostem



Zaključki



Protidružna kapa



Pokrov proti vetru



Stožčasta kapa



Vetna kapa



Konusni zaključek



Deflektor

Cevi



Cev 250mm



Cev 500mm



Cev 800mm



Cev 1000mm



Začetna cev 500mm



Začetna cev 1000mm



Nastavljiva cev 270mm - 470mm



Nastavljiva cev 550mm - 900mm



Nisbus 250mm



Nisbus 500mm

Nosilci



Tanka spojna objemka



Spojna objemka



Statična objemka



Stenski nosilec 50mm



Stenski nosilec tip 11 (70-110 mm od stene)



Stenski nosilec tip 21 (120-210 mm od stene)



Stenski nosilec tip 35 (210-350 mm od stene)

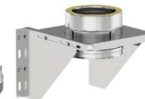

Nosilni element s troslojnim nastavkom in trikotno konzolo

T- kos



T-kos 87°



T-kos 90°



T-kos 45°



T-kos 45° Dolgi

Kolena



Koleno 15°



Koleno 30°



Koleno 45°



Koleno 87°



Koleno 90°



Koleno 90° z revizijsko odprtino

Artikli s čistilnim elementom



Cev z revizijsko odprtino (VZ)



Cev z okroglo revizijsko odprtino



T-kos 90° z revizijsko odprtino



Testna enota 250 mm



Testna enota 500 mm



Testna enota 1000 mm



Vse modularne skupine izdelkov sistema DW-25 so podrobno predstavljene, vključno z koleni, priključki, pritrdilnimi elementi,

adapterji in zaključki. Tehnične dimenzijske tabele za vsak element so na voljo za lažje načrtovanje namestitve in izbiro izdelkov. V tem poglavju so zbrani vsi bistveni tehnični podatki, potrebni med procesom načrtovanja in sestavljanja.

Cevi

SLX AB

d	80	100	130	150	180	200	230	250	280	300	350	400	450	500	550	600
D	130	150	180	200	230	250	280	300	330	350	400	450	500	550	600	650
H₂₅₀										200						
H₅₀₀										450						
H₈₀₀										750						
H₁₀₀₀										950						
m										50						

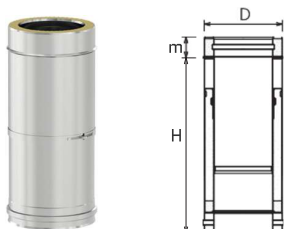

Nastavljiva cev (270 mm - 470 mm)

SLX AUB 47

d	80	100	130	150	180	200	230	250	300	350	400	450
D	130	150	180	200	230	250	280	300	350	400	450	500
Min.	240	240	240	240	240	240	240	240	240	240	240	240
Max.	420	420	420	420	420	420	420	420	420	420	420	420
m	50											

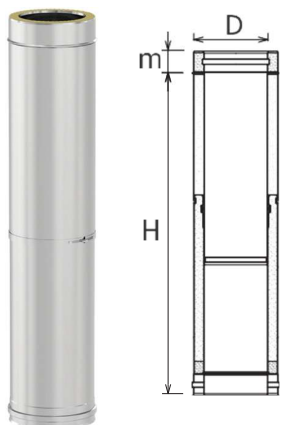

Nastavljiva cev (550 mm - 900 mm)

SLX AUB90

d	80	100	130	150	180	200	230	250	300	350	400	450
D	130	150	180	200	230	250	280	300	350	400	450	500
Min.	490	490	490	490	490	490	490	490	490	490	490	490
Max.	920	920	920	920	920	920	920	920	920	920	920	920
m	50											

Začetna cev 500 mm

SLX ABB 500

d	80	100	130	150	180	200	230	250	300
D	130	150	180	200	230	250	280	300	350
H	450	450	450	450	450	450	450	450	450
m	50	50	50	50	50	50	50	50	50

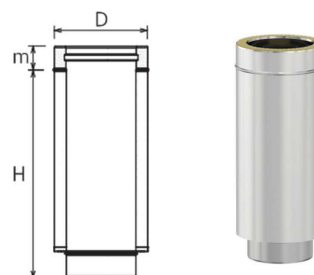

Začetna cev 1000 mm

SLX ABB 1000

d	80	100	130	150	180	200	230	250	300
D	130	150	180	200	230	250	280	300	350
H	950	950	950	950	950	950	950	950	950
m	50	50	50	50	50	50	50	50	50

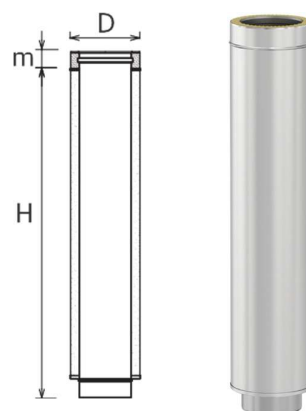

Nisbus (uvodnica) 250 mm

SLX ANB 250

d	100	130	150	180	200	230	250	300	350	400	450	500	550	600
D	150	180	200	230	250	280	300	350	400	450	500	550	600	650
H	200	200	200	200	200	200	200	200	200	200	200	200	200	200
m	50													

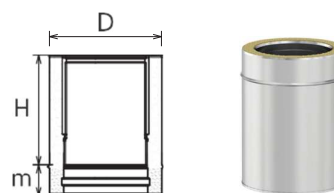

Nisbus (uvodnica) 500 mm

SLX ANB 500

d	100	130	150	180	200	230	250	300	350	400	450	500	550	600
D	150	180	200	230	250	280	300	350	400	450	500	550	600	650
H	450	450	450	450	450	450	450	450	450	450	450	450	450	450
m	50													

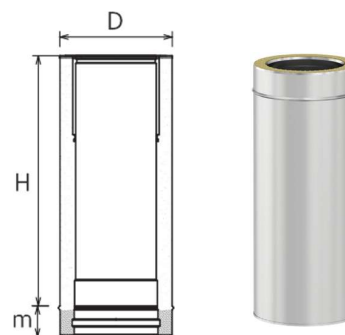

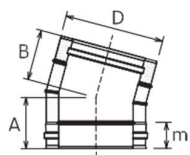

Koleno 15°

SLX AD15

d	80	100	130	150	180	200	230	250	300	350	400	450	500	550	600
D	130	150	180	200	230	250	280	300	350	400	450	500	550	600	650
A	105	105	105	105	105	105	105	118	118	118	118	125	125	125	125
B	94	105	105	105	105	105	105	118	118	118	118	125	125	125	125
m	50														

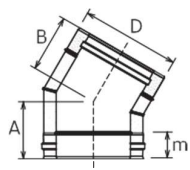

Koleno 30°

SLX AD30

d	80	100	130	150	180	200	230	250	300	350	400	450	500	550	600
D	130	150	180	200	230	250	280	300	350	400	450	500	550	600	650
A	100	105	118	118	118	118	130	130	143	143	155	155	170	170	183
B	100	105	118	118	118	118	130	130	143	143	155	155	170	170	183
m	50														

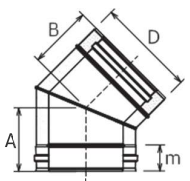

Koleno 45°

SLX AD45

d	80	100	130	150	180	200	230	250	300	350	400	450	500	550	600
D	130	150	180	200	230	250	280	300	350	400	450	500	550	600	650
A	100	117	125	125	143	143	143	155	155	170	183	200	205	220	250
B	100	117	125	125	143	143	143	155	155	70	183	200	205	220	250
m	50														

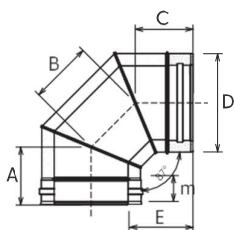

Koleno 87°

SLX AD 87

d	80	100	130	150	180	200	230	250	300	350	400	450	500	550	600
D	130	150	180	200	230	250	280	300	350	400	450	500	550	600	650
A	85	102	110	119	130	130	140	136	156	163	173	185	199	204	219
B	80	105	120	127	140	140	160	168	188	209	230	251	272	293	313
C	85	102	110	119	130	130	140	136	156	163	173	185	199	204	219
E	104	129	133	138	144	134	144	136	147	145	145	149	154	150	155
m	50														

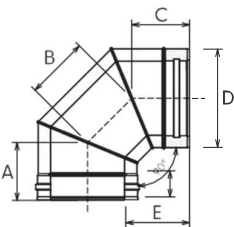

Koleno 90°

SLX AD 90

d	80	100	130	150	180	200	230	250	300	350	400	450	500	550	600
D	130	150	180	200	230	250	280	300	350	400	450	500	550	600	650
A	88	102	110	119	130	126	140	136	156	163	172	184	199	204	218
B	73	106	120	127	140	148	160	168	188	209	231	252	272	293	314
C	88	102	110	119	130	126	140	136	156	163	172	184	199	204	218
E	100	126	130	134	139	131	138	130	139	136	135	137	141	136	140
m	50														

Koleno 90° z revizijsko odprtino

SLX AD 90 I

d	80	100	130	150	180	200	230	250	300	350	400	450	500	550	600
D	130	150	180	200	230	250	280	300	350	400	450	500	550	600	650
A	88	102	110	119	130	126	140	136	156	163	172	184	199	204	218
B	73	106	120	127	140	148	160	168	188	209	231	252	272	293	314
C	88	102	110	119	130	126	140	136	156	163	172	184	199	204	218
E	100	126	130	134	139	131	138	130	139	136	135	137	141	136	140
m															50

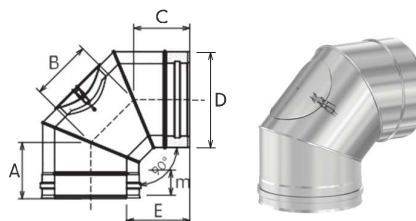

T - kos 87°

SLX AT87

d	80	100	130	150	180	200	230	250	300	350	400	450	500	550	600
D	130	150	180	200	230	250	280	300	350	400	450	500	550	600	650
H	283	350	350	450	450	450	450	450	550	550	650	700	700	950	950
B	150	160	175	185	200	210	225	235	260	295	320	345	370	420	445
m															50

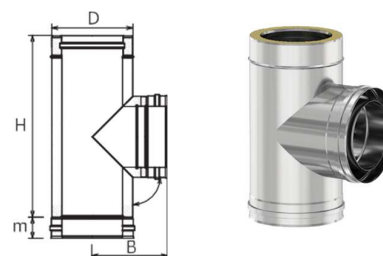

T - kos 90°

SLX AT90

d	80	100	130	150	180	200	230	250	300	350	400	450	500	550	600
D	130	150	180	200	230	250	280	300	350	400	450	500	550	600	650
H	283	350	350	450	450	450	450	450	550	550	650	700	700	950	950
B	150	160	175	185	200	210	225	235	260	295	320	345	370	420	445
m															50

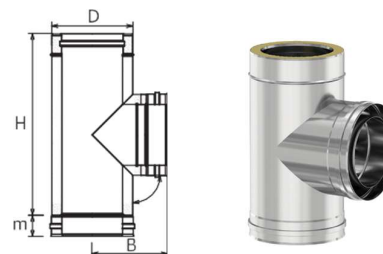

T - kos 45°

SLX AT135

d	100	130	150	180	200	230	250	300	350	400	450	500	550	600	
D	150	180	200	230	250	280	300	350	400	450	500	550	600	650	
H	350	450	450	550	550	550	650	650	950	950	950	950	1200	1200	
B	210	265	270	325	325	335	385	390	550	555	565	580	705	705	
m															50

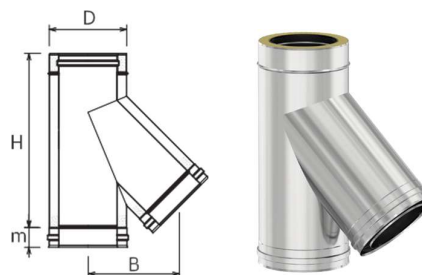

T - kos 45° dolgi

SLX AT135L

d	100	130	150	180	200										
D	150	180	200	230	250										
H	350	450	450	550	550										
m	50	50	50	50	50										
B	870	900	920	950	970										
E	720	720	720	720	720										
G	635	660	678	703	720										

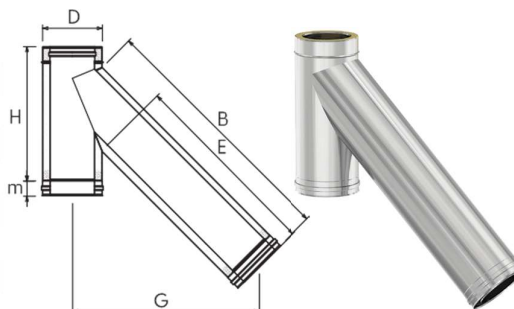

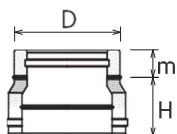

Redukcija troslojno na troslojno

SLX ACCR

d	100	130	150	180	200	230	250	300	350	400	450	500	550	600
D	150	180	200	230	250	280	300	350	400	450	500	550	600	650
H	170	170	170	200	200	200	200	200	200	200	200	200	200	200
m	50													

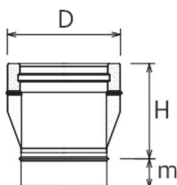

Enoslojno na troslojno (prehodni kos)

SLX ATRC

d	80	100	130	150	180	200	230	250	300	350	400	450	500	550	600
D	130	150	180	200	230	250	280	300	350	400	450	500	550	600	650
H	170	170	170	170	170	170	170	170	200	200	200	200	200	200	200
m	50														

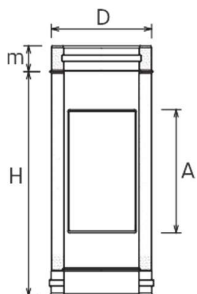

Cev z revizijsko odprtino (VZ)

SLX ATKB

d	150	180	200	230	250	300	350	400	450	500	550	600
D	200	230	250	280	300	350	400	450	500	550	600	650
A	256	256	256	256	256	256	256	256	256	256	256	256
H	450	450	450	450	450	450	450	450	450	450	450	450
A	50											

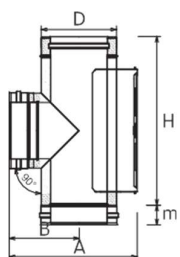

T-kos 90° z revizijsko odprtino

SLX ATKT

d	150	180	200	230	250	300	350	400	450	500	550	600
D	200	230	250	280	300	350	400	450	500	550	600	650
H	450	450	450	450	450	550	550	650	700	700	950	950
B	185	200	210	225	235	260	295	320	345	370	420	445
A	335	365	360	415	435	485	545	595	645	695	770	820
m	50											

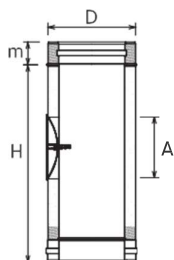

Cev z okroglo revizijsko odprtino

SLX ABI

d	80	100	130	150	180	200	230	250	300	350	400	450	500	550	600
D	130	150	180	200	230	250	280	300	350	400	450	500	550	600	650
H	450														
A	140														
m	50														

Cev za preskušanje strehe 250 mm

SLX ACOB 250

d	100	130	150	180	200	230	250	300	350	400	450	500	550	600
D	150	180	200	230	250	280	300	350	400	450	500	550	600	650
H	200	200	200	200	200	200	200	200	200	200	200	200	200	200
C	100													
m	50													

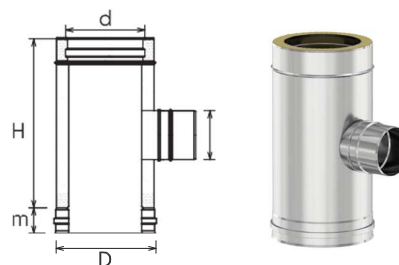

Testna enota 250 mm

SLX AOB 250

d	80	100	130	150	180	200	230	250	300	350	400	450	500	550	600
D	130	150	180	200	230	250	280	300	350	400	450	500	550	600	650
H	200	200	200	200	200	200	200	200	200	200	200	200	200	200	200
m	50														

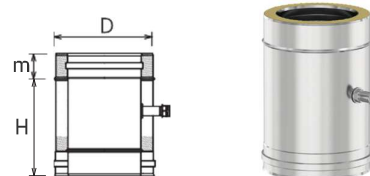

Testna enota 500 mm

SLX AOB 500

d	80	100	130	150	180	200	230	250	300	350	400	450	500	550	600
D	130	150	180	200	230	250	280	300	350	400	450	500	550	600	650
H	450	450	450	450	450	450	450	450	450	450	450	450	450	450	450
m	50														

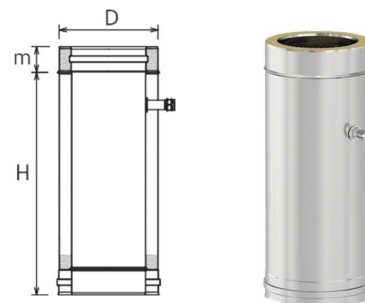

Testna enota 1000 mm

SLX AOB 1000

d	80	100	130	150	180	200	230	250	300	350	400	450	500	550	600
D	130	150	180	200	230	250	280	300	350	400	450	500	550	600	650
H	950	950	950	950	950	950	950	950	950	950	950	950	950	950	950
m	50														

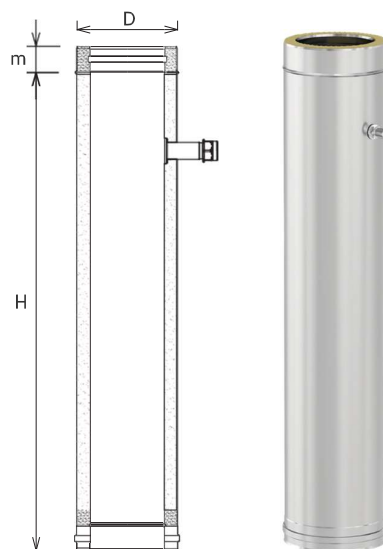

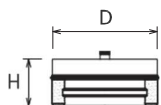

Dno dimnika s spodnjim odvodom

SLX AYT

d	80	100	130	150	180	200	230	250	300	350	400	450	500	550	600
D	130	150	180	200	230	250	280	300	350	400	450	500	550	600	650
H	80														

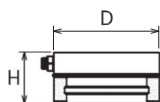

Dno dimnika s stranskim odvodom

SLX AYYT

d	80	100	130	150	180	200	230	250	300	350	400	450	500	550	600
D	130	150	180	200	230	250	280	300	350	400	450	500	550	600	650
H	80														

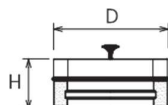

Dno dimnika brez odvoda

SLX ADTK

d	80	100	130	150	180	200									
D	130	150	180	200	230	250									
H	80														

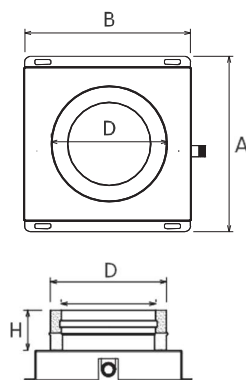
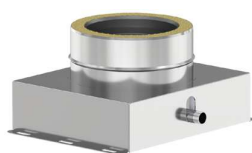

Talni odvod kondenza

AKSLX AYT

d	80	100	130	150	180	200	230	250	300	350					
D	130	150	180	200	230	250	280	300	350	400					
A	225	245	275	295	325	345	375	395	445	495					
B	180	200	230	250	280	300	330	350	400	450					
H	80														

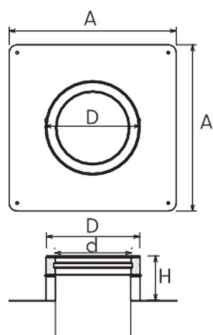
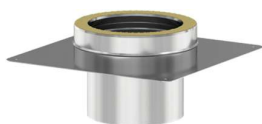

Prehodni kos s ploščo

AKSLX AUD

d	80	100	130	150	180	200	230	250	300	350					
D	130	150	180	200	230	250	280	300	350	400					
A	290	310	340	360	390	410	440	460	510	560					
A	290	310	340	360	390	410	440	460	510	560					
H	70														

Plošča z objemko

AKSLX AKD

d	80	100	130	150	180	200	230	250	300	350
D	130	150	180	200	230	250	280	300	350	400
A	300	320	350	370	400	420	450	470	520	570
A	300	320	350	370	400	420	450	470	520	570

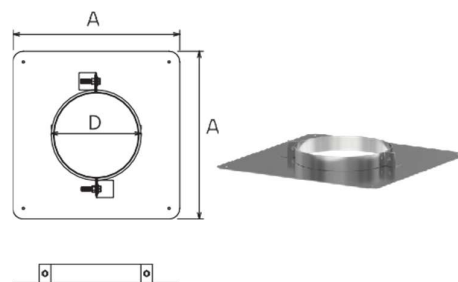

Vmesna nosilna plošča

AKSLX AOD

d	80	100	130	150	180	200	230	250	300	350
D	130	150	180	200	230	250	280	300	350	400
A	290	310	340	360	390	410	440	460	510	560
A	290	310	340	360	390	410	440	460	510	560
H					70					
H₂					70					

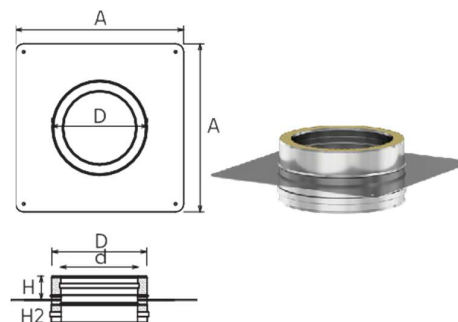

Proti dežna kapa

SLX AYKS

d	80	100	130	150	180	200	230	250
D	130	150	180	200	230	250	280	300
H	170	170	170	170	170	170	170	170



Vetna kapa

SLX ARKS

d	80	100	130	150	180	200	230	250	300
D	130	150	180	200	230	250	280	300	350
H	250	250	250	250	250	300	300	300	300

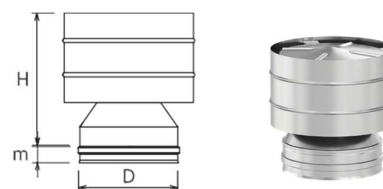

Stožčasta kapa

SLX ARKSL

d	80	100	130	150	180	200	230	250
D	130	150	180	200	230	250	280	300
H	250	250	250	250	250	300	300	300

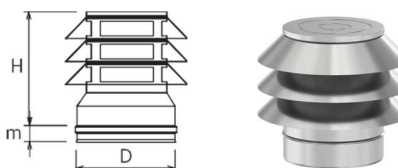

Statična objemka

AKSLX ABKT

d	80	100	130	150	180	200	230	250	300	350	400	450	500	550	600
D	130	150	180	200	230	250	280	300	350	400	450	500	550	600	650
A	200														

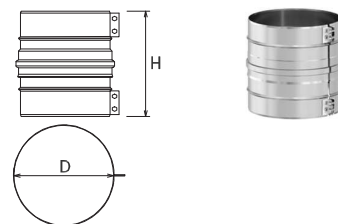

Nosilni element s troslojnim nastavkom in trikotno konzolo

AKSLX ABTS

d	80	100	130	150	180	200	230	250	300	350	400	450	500	550	600
D	130	150	180	200	230	250	280	300	350	400	450	500	550	600	650
A	200	220	250	270	300	320	350	370	420	470	480	570	620	670	720
B	230	250	280	300	330	350	380	400	450	500	550	600	650	700	750
H	190	210	240	260	290	310	340	360	410	460	460	560	610	660	710

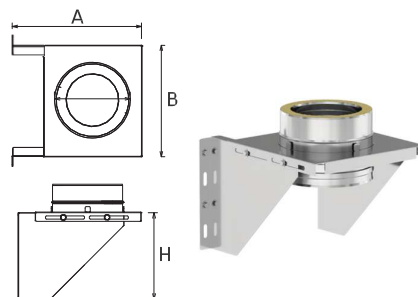

Nosilni podstavek

AKSLX ATT

d	80	100	130	150	180	200	230	250	300	350	400	450	500	550	600
D	130	150	180	200	230	250	280	300	350	400	450	500	550	600	650
B	360														
A	80														

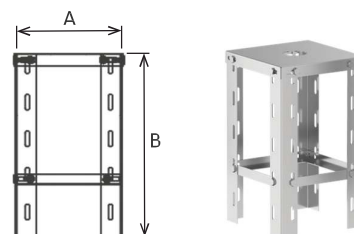

Nosilna konzola s troslojnim nastavkom 20

AKSLX ATA20

d	100	130	150	180	200	230	250	300	350
D	150	180	200	230	250	280	300	350	400
A	320	320	320	335	335	350	350	364	378
B	430	430	430	500	500	530	530	600	650
X	50-200 mm								



Nosilna konzola s troslojnim nastavkom 30

AKSLX ATA30

d	100	130	150	180	200	230	250	300	350
D	150	180	200	230	250	280	300	350	400
A	378	378	378	393	393	407	407	420	436
B	530	530	530	600	600	650	650	700	750
X	50-300 mm								

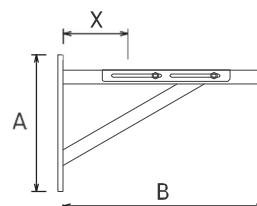

Nosilna konzola s troslojnim nastavkom 40

AKSLX ATA40

d	100	130	150	180	200	230	250	300	350
D	150	180	200	230	250	280	300	350	400
A	436	436	436	450	450	465	465	480	494
B	630	630	630	700	700	750	750	800	850
X	50-400 mm								

V kompletu je en par nosilnih konzol in troslojni nastavek

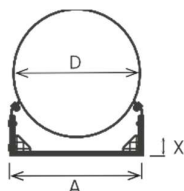

Stenski nosilec 50 mm od stene

AKSLX ADSK

d	80	100	130	150	180	200	230	250	300
D	130	150	180	200	230	250	280	300	350
A	163	175	205	225	255	276	280	300	329
X	50 mm								

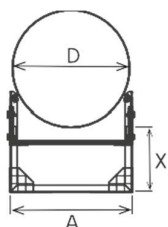

Srenski nosilec tip 11 (70-110 mm od stene)

AKSLX ADSK11

d	80	100	130	150	180	200	230	250	300
D	130	150	180	200	230	250	280	300	350
A	166	178	208	228	258	279	283	303	332
X	70-110 mm								

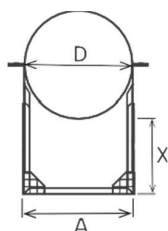

Stenski nosilec tip 21 (120-210 mm od stene)

AKSLX ADSK 21

d	80	100	130	150	180	200	230	250
D	130	150	180	200	230	250	280	300
A	137	157	187	207	237	257	287	307
X	120-210 mm							

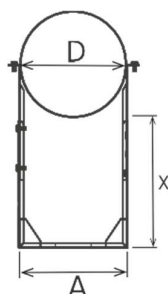

Stenski nosilec tip 35 (220-350 mm od stene)

AKSLX ADSK35

d	80	100	130	150	180	200	230	250
D	130	150	180	200	230	250	280	300
A	137	157	187	207	237	257	287	307
X	220-350 mm							

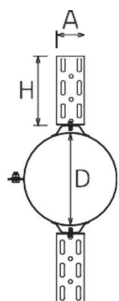

Podpora za špirovce

AKSLX AUK

d	80	100	130	150	180	200	230	250	300	350	400	450	500	550	600
D	130	150	180	200	230	250	280	300	350	400	450	500	550	600	650
A	60														
H	155														

Nastavljiva podpora

AKSLX AHT

d	80	100	130	150	180	200	230	250	300	350	400	450	500	600
D	130	150	180	200	230	250	280	300	350	400	450	500	550	650
A	200 / 300 / 400 / 500 / 600 mm													

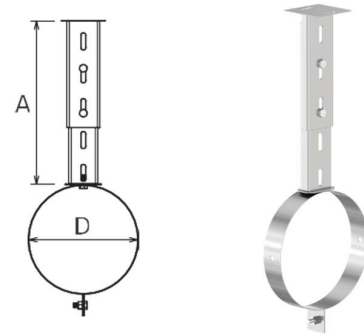

Dolg nastavljiva podpora

AKSLX AHTU

d	80	100	130	150	180	200	230	250	300	350	400	450	500	550	600
D	130	150	180	200	230	250	280	300	350	400	450	500	550	600	650
A	610 - 1000 mm														

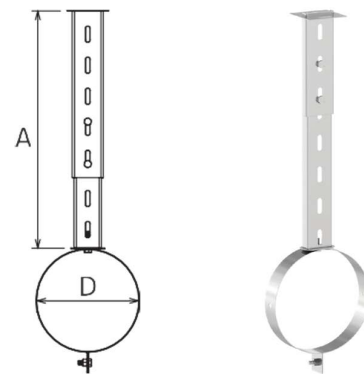

Sidrna objemka

AKSLX AGK

d	80	100	130	150	180	200	230	250	300	350	400	450	500	550	600
D	130	150	180	200	230	250	280	300	350	400	450	500	550	600	650

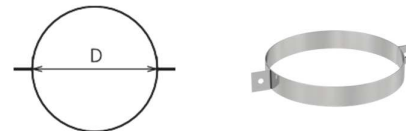

Sidrna objemka (4)

AKSLX AAK

d	80	100	130	150	180	200	230	250	300	350	400	450	500	550	600
D	130	150	180	200	230	250	280	300	350	400	450	500	550	600	650

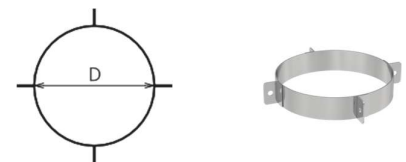

Proti dežni obroč

AKSLX ACOB

d	80	100	130	150	180	200	230	250	300	350	400	450	500	550	600
D	130	150	180	200	230	250	280	300	350	400	450	500	550	600	650
A	190	210	240	260	290	310	370	390	440	490	540	590	640	690	740
H	80	80	80	80	80	80	80	80	100	100	100	100	100	100	100

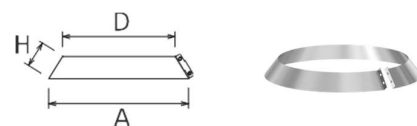

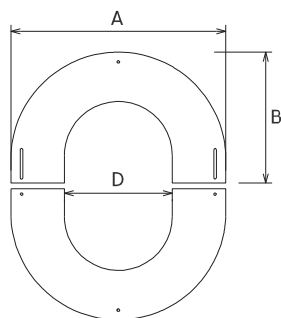

Ovalna stenska rozeta 30°

AKSLX AOK30

d	80	100	130	150	180	200	230	250	300	350	400
D	130	150	180	200	230	250	280	300	350	400	450
A	330	350	380	400	430	450	480	500	550	600	650
B	185	198	215	227	244	255	273	285	313	340	370

Ovalna stenska rozeta 45°

AKSLX AOK45

d	80	100	130	150	180	200	230	250	300	350	400
D	130	150	180	200	230	250	280	300	350	400	450
A	330	350	380	400	430	450	480	500	550	600	650
B	205	218	239	253	274	288	310	324	359	385	420

Ovalna stenska rozeta 90°

AKSLX AOK90

d	80	100	130	150	180	200	230	250	300	350	400
D	130	150	180	200	230	250	280	300	350	400	450
A	330	350	380	400	430	450	480	500	550	600	650

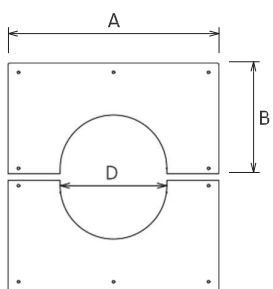

Stenska rozeta 30°

AKSLX ADK30

d	80	100	130	150	180	200	230	250	300	350	400
D	130	150	180	200	230	250	280	300	350	400	450
A	330	350	380	400	430	450	480	500	550	600	650
B	175	190	205	220	235	250	265	280	310	335	360

Stenska rozeta 45°

AKSLX ADK45

d	80	100	130	150	180	200	230	250	300	350	400
D	130	150	180	200	230	250	280	300	350	400	450
A	330	350	380	400	430	450	480	500	550	600	650
B	195	210	230	245	270	280	300	320	350	410	460

Stenska rozeta 90°

AKSLX ADK90

d	80	100	130	150	180	200	230	250	300	350	400
D	130	150	180	200	230	250	280	300	350	400	450
A	330	350	380	400	430	450	480	500	550	600	650
B	175	185	200	210	225	235	250	260	285	310	335

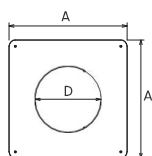
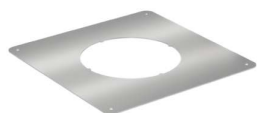

Pokrivna rozeta

AKSLX YKPD

d	80	100	130	150	180	200	230	250	300	350	400
D	130	150	180	200	230	250	280	300	350	400	450
A	310	330	360	380	410	430	460	480	530	580	630
A	310	330	360	380	410	430	460	480	530	580	630

Prezračevalna rozeta

AKSLX AYKP

d	80	100	130	150	180	200	230	250	300	350	400
D	130	150	180	200	230	250	280	300	350	400	450
A	310	330	360	380	410	430	460	480	530	580	630
A	310	330	360	380	410	430	460	480	530	580	630

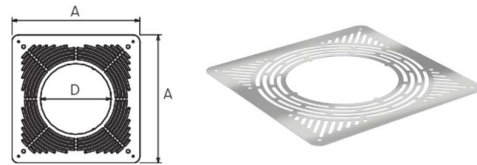

Pokrivna rozeta

AKSLX AYKPK

d	80	100	130	150	180	200	230	250	300	350	400
D	130	150	180	200	230	250	280	300	350	400	450
A	310	330	360	380	410	430	460	480	530	580	630
A	310	330	360	380	410	430	460	480	530	580	630

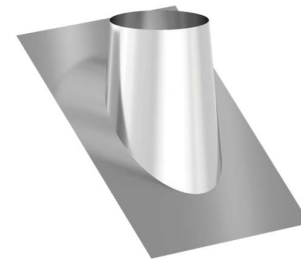
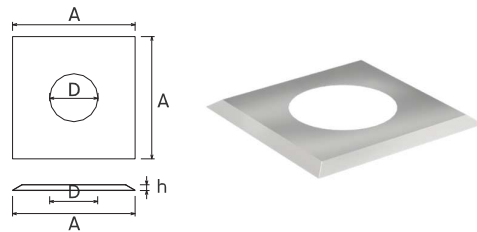

Dimniška obroba 5-30

AKSLX ACO 30

d	80	100	130	150	180	200	230	250	300	350	400	450
D	130	150	180	230	250	250	280	300	350	400	450	500
A	580	600	630	660	690	710	740	770	820	880	930	980
B	530	580	610	640	670	690	720	750	800	860	910	960
H	150	150	150	150	150	150	150	150	150	150	150	150
C	130	195	230	255	290	310	345	370	425	485	540	600

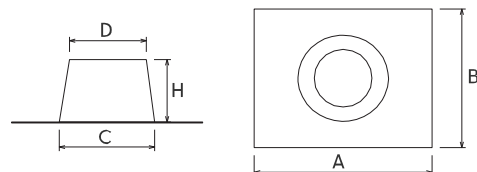

Dimniška obroba 30-45

AKSLX ACO 45

d	80	100	130	150	180	200	230	250	300	350	400	450
D	130	150	180	230	250	250	280	300	350	400	450	500
A	595	640	680	710	750	780	825	850	920	960	1000	1100
B	575	620	660	690	730	760	805	830	900	940	980	1080
H	150	150	150	150	150	150	150	150	150	150	150	150
C	195	240	280	310	350	380	425	450	520	590	665	735

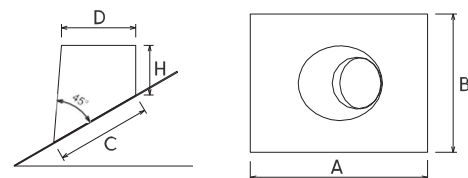

Dimniška obroba 90

AKSLX ACO 90

d	80	100	130	150	180	200	230	250	300	350	400	450
D	130	150	180	230	250	250	280	300	350	400	450	500
A	590	610	640	660	690	710	740	760	810	860	910	960
B	590	610	640	660	690	710	740	760	810	860	910	960
H	150	150	150	150	150	150	150	150	150	150	150	150
C	190	210	240	260	290	310	340	360	410	460	510	560

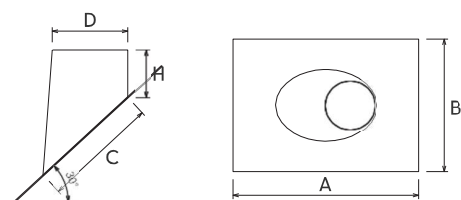

Ø	vertikalno			vodoravno			vertikalno			vodoravno		
	DOLŽINA	ODMIK	VIŠINA	DOLŽINA	ODMIK	VIŠINA	DOLŽINA	ODMIK	VIŠINA	DOLŽINA	ODMIK	VIŠINA
	T - kos 45° + CEV + KOLENO 45°			T - kos 45° + CEV + KOLENO 45°			T - kos 45° DOLGI + CEV + KOLENO 45°			T-kos 45° DOLGI + CEV + KOLENO 45°		
80-130							1000	940	1155	1000	1070	1090
							800	799	1014	800	929	949
							500	587	802	500	717	737
							250	410	625	250	540	560
							-	268	483	-	399	419
100-150	1000	1356	1548	1000	1473	1431	1000	931	1123	1000	1048	1006
	800	1204	1396	800	1332	1290	800	779	971	800	906	864
	500	1003	1195	500	1120	1078	500	577	769	500	694	652
	250	826	1018	250	943	901	250	401	593	250	518	476
	-	684	876	-	801	759	-	259	451	-	376	334
130-180	1000	1391	1631	1000	1521	1501	1000	997	1236	1000	1126	1107
	800	1249	1489	800	1379	1359	800	855	1095	800	985	965
	500	1037	1277	500	1167	1147	500	643	883	500	773	753
	250	861	1100	250	990	971	250	466	706	250	596	576
	-	719	959	-	849	829	-	325	565	-	455	435
150-200	1000	1407	1636	1000	1536	1507	1000	1000	1228	1000	1128	1100
	800	1266	1494	800	1394	1366	800	858	1087	800	987	958
	500	1054	1282	500	1182	1154	500	646	875	500	775	746
	250	877	1105	250	1005	977	250	469	698	250	598	569
	-	735	964	-	864	835	-	328	556	-	456	428
180-230	1000	1442	1720	1000	1585	1577	1000	1062	1340	1000	1205	1197
	800	1301	1578	800	1443	1436	800	921	1198	800	1063	1056
	500	1089	1366	500	1231	1224	500	709	986	500	851	844
	250	912	1190	250	1055	1047	250	532	809	250	674	667
	-	771	1048	-	913	906	-	391	668	-	533	526
200-250	1000	1459	1727	1000	1602	1584	1000	1066	1333	1000	1208	1191
	800	1318	1585	800	1460	1443	800	924	1192	800	1067	1049
	500	1106	1373	500	1248	1231	500	712	979	500	854	837
	250	929	1196	250	1071	1054	250	535	803	250	678	660
	-	788	1055	-	930	913	-	394	661	-	536	519
250-300							1000	1139	1444	1000	1294	1289
							800	997	1302	800	1152	1147
							500	785	1090	500	940	935
							250	608	913	250	763	758
							-	467	772	-	622	617
300-350							1000	1149	1444	1000	1319	1274
							800	1008	1303	800	1178	1133
							500	796	1091	500	966	921
							250	620	915	250	789	744
							-	478	773	-	648	603

Ø	vertikalno			vodoravno			navpično			vodoravno		
	DOLŽINA	ODMIK	VIŠINA	DOLŽINA	ODMIK	VIŠINA	DOLŽINA	ODMIK	VIŠINA	DOLŽINA	ODMIK	VIŠINA
80-130	1000	1075	950	1000	1205	820	1000	1343	567	1000	1407	287
	800	933	808	800	1064	679	800	1170	468	800	1214	236
	500	721	596	500	852	467	500	910	318	500	924	158
	250	545	420	250	675	290	250	693	192	250	683	93
	-	403	278	-	533	148	-	520	93	-	490	41
100-150	1000	1029	919	1000	802	1146	1000	1281	555	1000	1339	287
	800	876	766	800	660	1004	800	1097	449	800	1196	235
	500	675	565	500	448	792	500	848	305	500	906	157
	250	498	388	250	271	615	250	631	180	250	504	93
	-	357	247	-	130	474	-	458	80	-	471	41
130-180	1000	1075	950	1000	1208	820	1000	1337	566	1000	1404	287
	800	933	808	800	1063	678	800	1164	466	800	1211	235
	500	721	596	500	851	466	500	904	316	500	925	158
	250	544	419	250	674	290	250	687	191	250	679	93
	-	403	278	-	533	148	-	514	91	-	486	41
150-200	1000	1082	947	1000	1210	818	1000	1348	566	1000	1417	287
	800	940	805	800	1069	677	800	1175	466	800	1223	235
	500	728	593	500	857	465	500	915	316	500	934	158
	250	551	416	250	680	288	250	699	191	250	692	93
	-	410	275	-	539	146	-	525	91	-	499	41
180-230	1000	1130	980	1000	1275	838	1000	1367	567	1000	1432	287
	800	989	839	800	1131	696	800	1194	467	800	1238	235
	500	777	627	500	919	484	500	934	317	500	949	158
	250	600	450	250	742	307	250	717	192	250	707	93
	-	458	308	-	601	166	-	544	92	-	514	41
200-250	1000	1140	980	1000	1282	838	1000	1374	567	1000	1440	287
	800	998	838	800	1141	696	800	1201	467	800	1247	235
	500	786	626	500	928	484	500	941	317	500	957	158
	250	609	437	250	752	307	250	725	192	250	716	93
	-	471	311	-	610	166	-	552	92	-	523	41
250-300	1000	1196	1011	1000	1351	856	1000	1450	580	1000	1516	294
	800	1054	869	800	1209	714	800	1276	480	800	1324	242
	500	845	660	500	1000	505	500	1017	330	500	1033	164
	250	665	480	250	820	325	250	800	205	250	792	100
	-	524	339	-	679	184	-	627	105	-	599	48
300-350	1000	1257	1047	1000	1427	877	1000	1521	583	1000	1541	294
	800	1115	905	800	1285	735	800	1348	493	800	1348	242
	500	903	663	500	1073	523	500	1088	343	500	1058	164
	250	728	518	250	898	348	250	872	218	250	817	100
	-	585	375	-	756	206	-	699	118	-	624	48

Ø	KOLENO 45° + CEV + KOLENO 45° vertikalno			KOLENO 45° + CEV + KOLENO 45° vodoravno			KOLENO 30° + CEV + KOLENO 30° navpično			KOLENO 15° + CEV + KOLENO 15° vodoravno		
	DOLŽINA	ODMIK	VIŠINA	DOLŽINA	ODMIK	VIŠINA	DOLŽINA	ODMIK	VIŠINA	DOLŽINA	ODMIK	VIŠINA
80-130	1000	820	1030	1000	950	900	1000	568	1168	1000	287	1232
	800	679	889	800	809	759	800	467	995	800	236	1039
	500	467	677	500	596	547	500	319	734	500	158	749
	250	290	500	250	420	370	250	192	518	250	93	508
	-	148	358	-	278	228	-	92	345	-	41	315
100-150	1000	802	986	1000	919	944	1000	555	1071	1000	287	1179
	800	660	844	800	777	802	800	449	937	800	235	1036
	500	448	632	500	565	590	500	305	688	500	157	746
	250	271	455	250	388	413	250	180	471	250	93	504
	-	130	314	-	247	272	-	80	298	-	41	311
130-180	1000	820	1029	1000	950	990	1000	566	1162	1000	287	1229
	800	678	888	800	808	848	800	466	989	800	235	1028
	500	466	676	500	596	636	500	316	729	500	158	750
	250	290	499	250	419	459	250	191	512	250	93	540
	-	148	358	-	278	318	-	91	339	-	41	311
150-200	1000	818	1025	1000	947	997	1000	566	1163	1000	287	1232
	800	677	884	800	805	855	800	466	990	800	235	1038
	500	465	672	500	593	643	500	316	730	500	158	749
	250	288	495	250	416	466	250	191	514	250	93	507
	-	146	354	-	275	325	-	91	340	-	41	314
180-230	1000	838	1072	1000	980	1045	1000	567	1167	1000	287	1232
	800	696	931	800	839	904	800	467	994	800	235	1028
	500	484	719	500	627	692	500	317	734	500	144	749
	250	307	542	250	450	515	250	192	517	250	93	507
	-	166	401	-	308	373	-	92	344	-	41	314
200-250	1000	838	1072	1000	980	1055	1000	567	1164	1000	287	1230
	800	696	931	800	838	913	800	467	991	800	235	1037
	500	487	722	500	630	705	500	317	731	500	158	747
	250	311	545	250	453	528	250	192	515	250	93	506
	-	166	400	-	308	383	-	92	342	-	41	313
250-300	1000	856	1116	1000	1011	961	1000	580	1215	1000	294	1281
	800	714	974	800	869	819	800	480	1041	800	242	1089
	500	505	765	500	657	610	500	330	782	500	164	798
	250	325	585	250	480	430	250	205	565	250	100	557
	-	184	444	-	339	289	-	105	392	-	48	364
300-350	1000	877	1167	1000	1047	997	1000	593	1261	1000	294	1281
	800	735	1025	800	905	855	800	493	1088	800	242	1088
	500	523	813	500	693	643	500	343	828	500	164	798
	250	348	638	250	518	468	250	218	612	250	100	557
	-	206	496	-	375	325	-	118	439	-	48	364

Saval Aleš Avsenek d.o.o.

info@dimniki-kamini.si

www.trgovina-kamin.si

www.dimniki-kamini.si

Kranjska cesta 2, 4240 Radovljica

Kontakt:

Trgovina Kamin: 040 364 636 / 04 53 000 40

Aleš Avsenek: 041 229 246



TRGOVINA
ZA TOPLE ZIMSKÉ DNI

KAMIN



SAVAL

Prodaja kaminov,
Sanacije dimnikov z nerjavečimi cevmi
Povrtavanje in montaža, Diamantno vrtačje
☎ 041 229 246

